

Spherical plain bearing

GOHR-K...DO-GIHR-K50DO

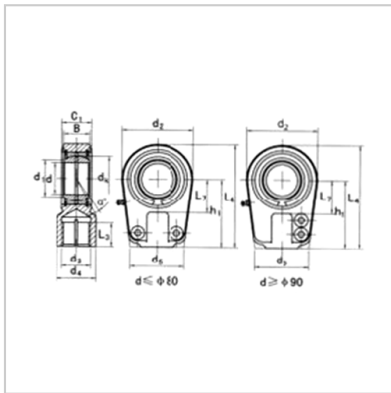

model :	GIHR-K50DO
---------	------------

Size mm :

d :	50
d3 6H :	M45 × 1.5
D :	61
L ø :	46
B :	35
C1 :	40
d2 :	116
L7 min :	55
h1 :	105
L4 :	168
d5 :	90
d1 :	55.9
dk :	66
:	6

Load KN :

move :	156
quiet :	365
Weight kg :	3.8

: