

Spherical plain bearing

GOHR-K...DO-GIHR-K35DO

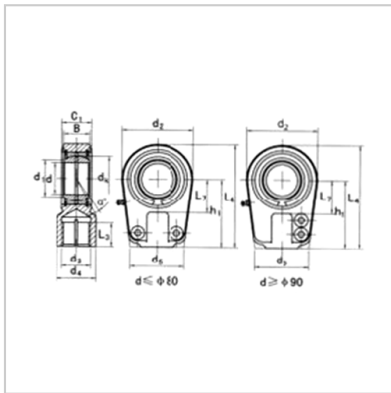

model : GIHR-K35DO

Size mm :

d :	35
d3 6H :	M28 × 1.5
D :	40
L ø :	29
B :	25
C1 :	30
d2 :	78
L7 min :	38
h1 :	70
L4 :	112
d5 :	66
d1 :	39.8
dk :	47
:	6

Load KN :

move :	80
quiet :	153
Weight kg :	1.2

: